

Canal impeller - free passage 80mm



BZ 3-phase
50Hz

Specifications:

Model		Colour code curve	Bore mm	Power output kW	Phases	r.p.m.	Head max. m	Capacity max. l/min	Starting method	Dry weight kg without cable		Impeller passage mm
free standing	with guide rail fitting									free standing	with guide rail fitting	
80BZ41.5	TOS80BZ41.5	● 1	80	1,5	3	1450	8,5	1400	direct	78,0	74,0	80



ø Discharge bore mm		80mm	
Pumping Fluid	Temperature	0-40°C	
	Type of Fluid	Municipal sewage	
Pump	Components	Impeller	Non-clog impeller
		Shaft Seal	Double mechanical seal
		Bearings	Shielded ball bearings
	Material	Impeller	Grey iron casting EN-GJL-200
		Casing	Grey iron casting EN-GJL-200
		Suction Plate	Grey iron casting EN-GJL-200
Shaft Seal	Silicon carbide in oil bath		
Motor	Type, Poles		Induction motor, 4 poles, IP68
	Lubrication		Turbine oil (ISO VG32)
	Insulation		Insulation class F
	Motor Protector (built-in)		Circle thermal cut-out
	Phase / Voltage		3-phase / 400V / 50Hz / d.o.l.
	Material	Casing	Grey iron casting EN-GJL-150
		Shaft	Stainless steel EN-X30Cr13
Cable		Rubber, 10m H07RN-F	
Discharge Connection		Inside thread, JIS10K flange	
Optional Accessories		Guide rail fitting "TOS" (guide support, duck foot bend, lifting chain) / Bend and stand set for free standing types	

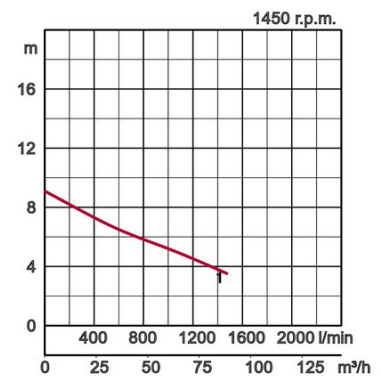

Model	A	A1	A2	A3	B	D	D1	D2	H	W1	W2
80BZ41.5	523	302	129	190	303	273	133	140	631	235	590

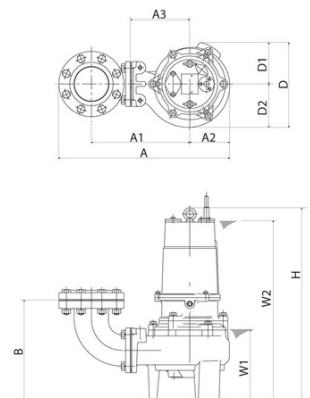

W1: lowest running water level